

## **TDR Measurement using the J2154A PerfectPulse® Differential TDR and the MSO68B Oscilloscope**

By Benjamin Dannan and Steven Sandler, Picotest.com

Most modern circuit designs depend on accurate logic signals at the logic receiver. This assurance is based on the careful design of printed circuit board (PCB) transmission lines, interconnects, and cables.

If you have designed a controlled impedance transmission line based on a PCB stack-up, how do you know if the PCB fabrication house or another vendor built your stack-up to meet your controlled impedance specification?

It is common for controlled impedance printed circuit boards to often include a measurement “coupon”, which typically includes sample traces about 6 inches long, and is constructed as part of the printed circuit board panel. They are measured to verify the PCB stack-up and the accuracy of the PCB transmission lines. These coupons, as well as the actual PCB signal traces, interconnects, and cables are typically measured using a Time Domain Reflectometer (TDR). TDR impedance measurements are essential for ensuring signal integrity in a PCB design.

A TDR measures the reflections that result from a signal traveling through a transmission environment of some kind, which could be a circuit board trace, a cable, a connector, and so on. In the past, a TDR was often a large, expensive instrument that included a high-speed edge pulse and a sampling oscilloscope. A TDR is a great tool that can be used to qualify vendor stack-ups, such as identifying the dielectric constant ( $D_k$ ) variation of impedance. Some examples of information that can be provided by a TDR are shown in Figures 1, 2, and 3.

Figure 1 demonstrates how impedance discontinuities can be measured on a PCB trace. Figure 2 is an example of TDR data computed from measured S-parameters, along with labels on the various features. In this case, the individual elements such as vias, traces, and connectors are clearly visible in the TDR trace [2]. A TDR is particularly useful for verifying connector and cable continuity. Depending on the total system rise time, the same result could be achieved with a TDR directly measuring the same DUT. This will be discussed in more detail later in this application note.

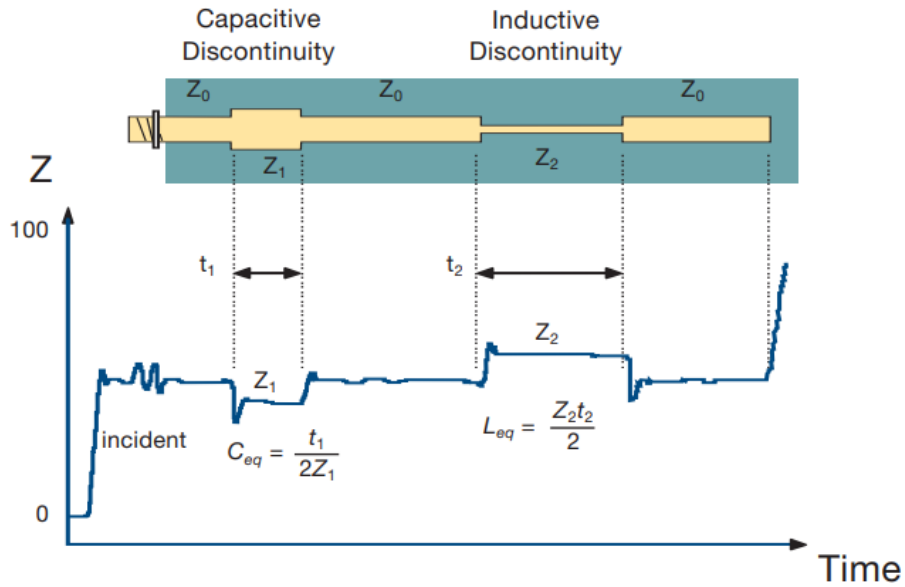


Fig. 1 - TDR Waveform Reveals Trace Discontinuities [1].

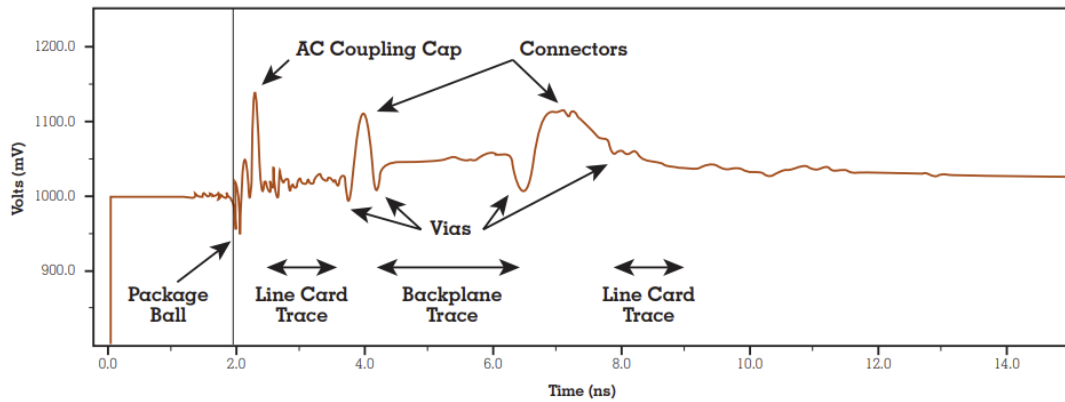
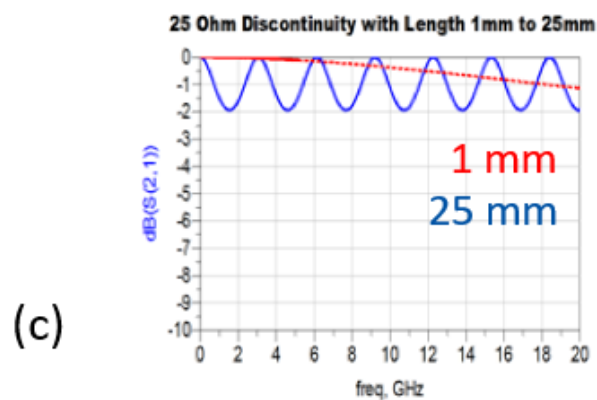
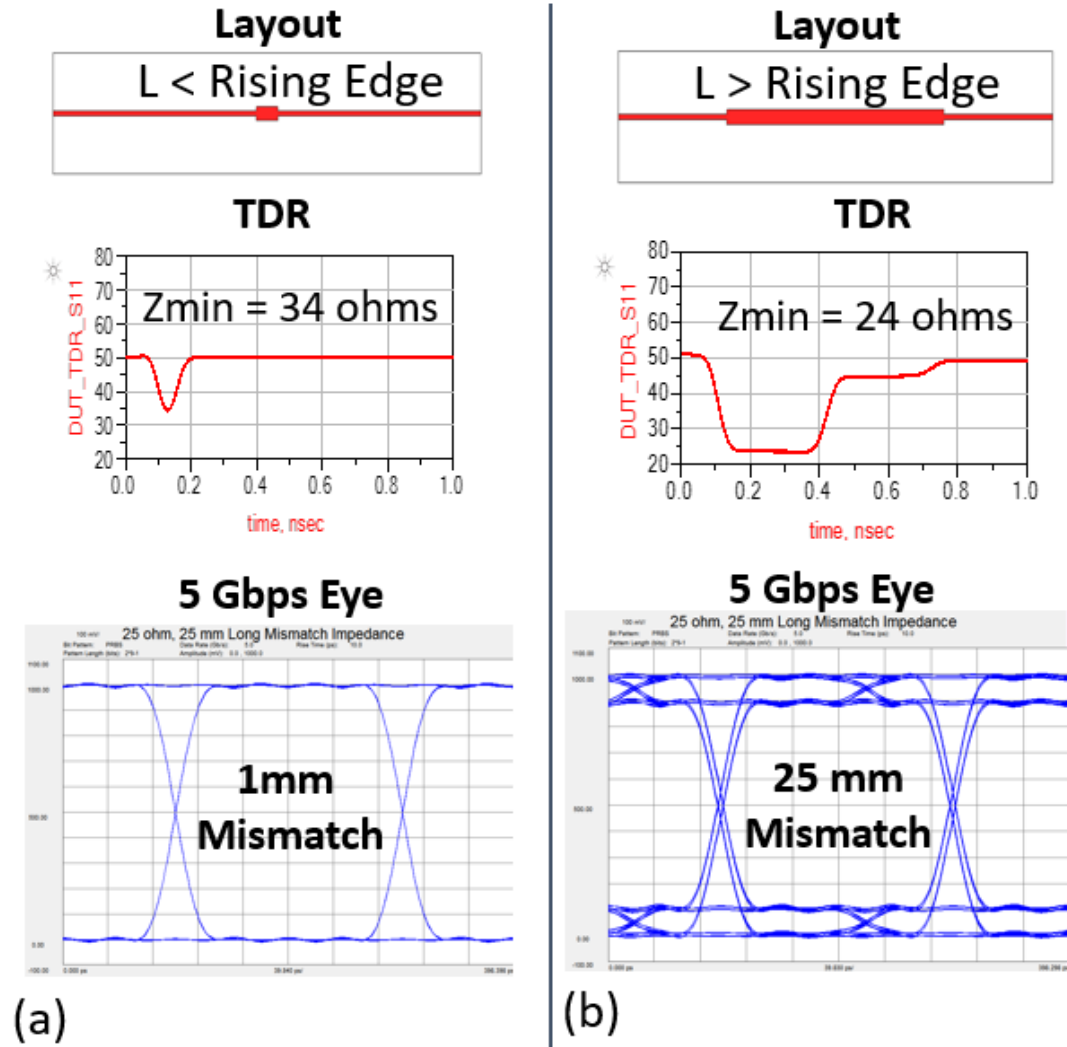


Fig. 2 - SiSoft Article Example TDR Derived from Measured S-parameter Data [2].

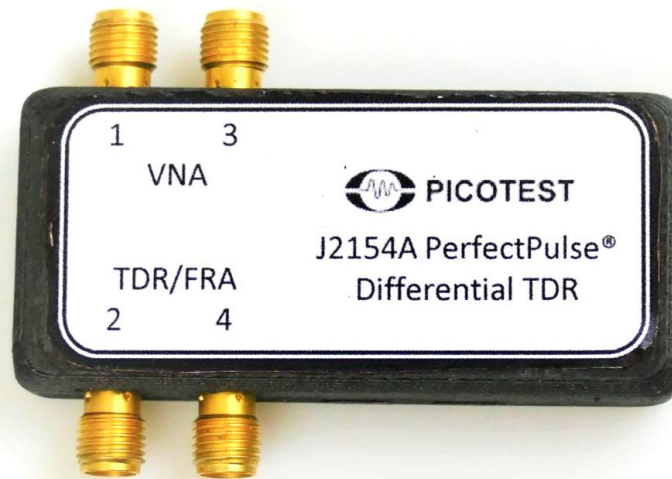
As shown in Figure 3, the simulated TDR response of an impedance discontinuity for a channel, the response of the eye diagram can be correlated to understand the impact. The same measurement correlation could be done for a stub that may exist in the actual channel.



**Fig. 3 - TDR and Eye Diagrams for Series Impedance Discontinuities Shorter (a) and Longer (b) than the Signal Rise Time. Insertion Loss for the Same Discontinuities (c) [3].**

A TDR is a single port measurement, where the Time Domain Transmissometer (TDT) is a 2-port measurement. The TDR shows where reflections are occurring, which reduces the amount of signal that reaches the transmitter. The TDT shows how the rise time is degraded by material losses in the channel. The near-end crosstalk (NEXT) on adjacent channels shows which component is the likely source of noise coupling by being coincident in time with the component's TDR reflection [3].

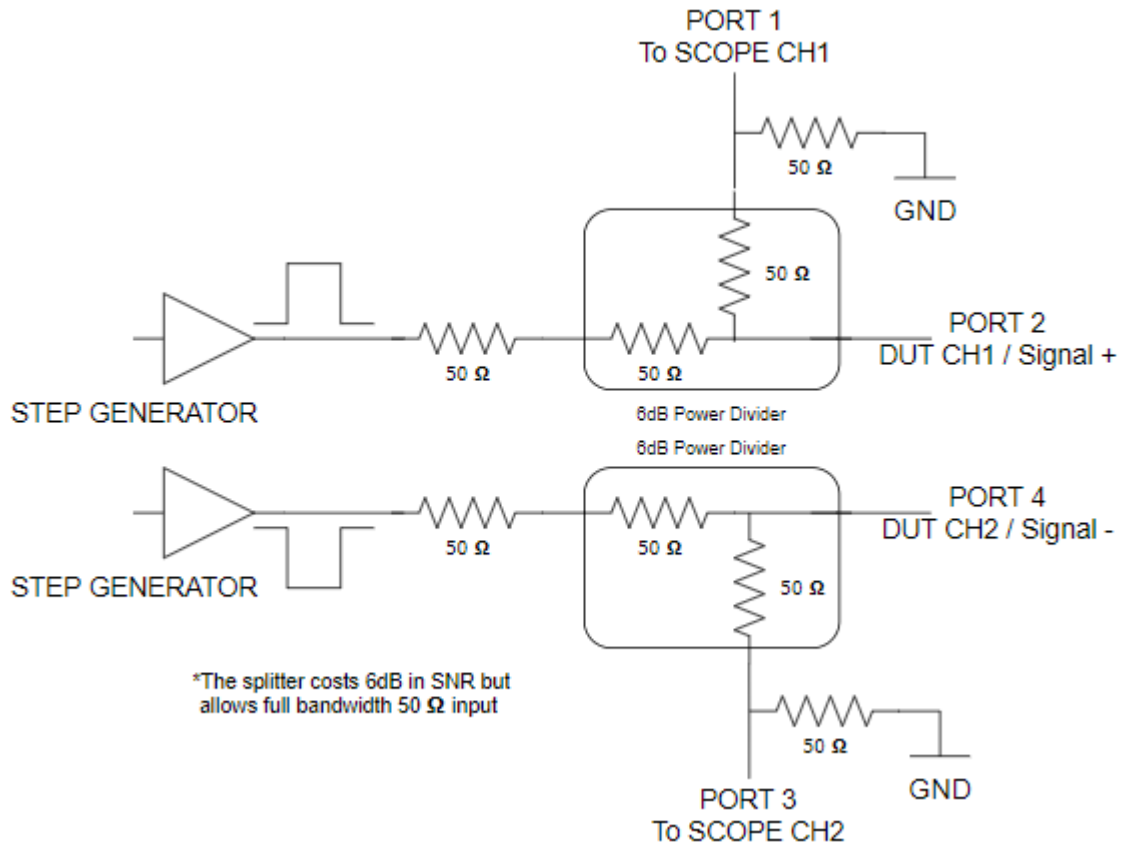
The Picotest J2154A PerfectPulse® Differential TDR is a low-cost, USB-powered, 10.5GHz pocket-sized TDR. The J2154A is designed to work with real-time and sampling oscilloscopes to perform single-ended and differential measurements. The J2154A presents two complementary (differential) pulses in order to be used as a differential TDR. However, when using two or more oscilloscope “receiver” channels, the J2154A can also be used for single-ended and differential TDT. The J2154A requires the Time Domain Reflectometry software 4-TDR, 5-TDR, or 6-TDR when used with a Tektronix MSO4B, MSO5B and MSO6B oscilloscope.



**Fig. 4 - Depiction of Picotest J2154A TDR and Its Connections.**

As shown in Fig. 4, for single-ended and differential mode TDR measurements, connectors 1 and 3 connect to the oscilloscope channels, while connectors 2 and 4 connect to the probes. This is the native mode and most common mode of operation. These can be either single-ended or differential measurements.

The internal signal generator, combined with an included resistive port splitter, and coupled to a real-time oscilloscope can be used as a precise TDR/TDT measurement system. It can measure PCB test coupon impedance, cables, and bad crimps, trace length, Dk, and velocity factor ( $V_f$ ).



**Fig. 5 - Differential TDR Diagram.**

A differential TDR such as the J2154A is useful for measuring the odd- and even-mode impedances of a coupled pair of transmission lines, enabling calculation of its characteristic impedance matrix elements and thus the differential impedance. A simplified differential TDR diagram is shown in Figure 5.

The J2154A TDR can also be used to measure crosstalk between two adjacent traces. A single-ended TDR channel can be used to generate the exciting waveform for the active line. The voltage induced on the quiet line is then measured with a second receiver channel on the oscilloscope. During this procedure, the unattached ends of the two transmission lines should be terminated at 50Ω to keep the loads the same as when the cables are attached.

This application note demonstrates how to use the Picotest J2154A TDR to measure PCB transmission lines, cable and interconnect impedance, dielectric constant, velocity factor, and cable length.

## 1.0 TDR Resolution

The TDR measures the DUT as impedance versus time. By referencing time, then it is possible to convert time to distance. With this information, a TDR can help us determine the length of a cable, the length until a cable fault, where to find the end of a cable, as well as a location of discontinuity on a trace.

As shown by EQ(1), the speed of light, in a vacuum, is defined as:

$$c = 2.99792468 \cdot 10^8 \text{ m/s} = 11.86 \frac{\text{in}}{\text{ns}} \quad (1)$$

where the velocity factor ( $V_p$ ) of the signal transmission, sometimes referred to as the velocity of propagation, through a medium is defined as:

$$V_p = \frac{c}{\sqrt{D_k}} \quad (2)$$

From EQ(2), the propagation delay can be derived, which is defined as:

$$T_D = \frac{\text{length (in)}}{V_p \text{ (in/ns)}} \quad (3)$$

It is important to keep in mind that the TDR measures the reflection, which is a round trip measurement. So the result seen on the oscilloscope by EQ(3) will be the round trip time delay.

As an example, if  $D_k = 3.5$ , then by EQ(2), the velocity factor is found

$$V_p = \frac{11.86 \text{ in/ns}}{\sqrt{3.5}} = 6.33 \text{ in/ns} \quad (4)$$

Thus, for  $D_k = 3.5$ , the time delay per inch can be calculated, by EQ(3), as

$$T_{D/inch} = \frac{1}{6.33 \text{ (in/ns)}} = 157.7 \text{ ps/in} \quad (5)$$

Based on EQ(5), if we were to measure a real transmission line, with  $D_k = 3.5$ , using the J2154A TDR, we would expect to see a result of  $2 \cdot 157.7 \text{ ps/in} = 315.4 \text{ ps/in}$  to include the round trip delay.

It is important to remember that the addition of a cable and/or probe will further slow down the edge of the TDR (and reduce the bandwidth), which will increase the minimum resolution. Where the resolution is the fidelity available in order to be able to distinguish between two or more separate artifacts during the TDR measurement. It is important to understand that the rise time of the TDR signal and the total system rise time will affect the resolution you can see for discontinuities and/or artifacts on your DUT.

In other words, when making TDR measurements, emphasis on how much bandwidth you need and the resolution of the TDR needs to be considered in order to capture the resolution fidelity of the structures you're trying to measure on the DUT.

Per IPC-TM-650 Test Methods Manual [4], the TDR resolution limit is defined as

$$\text{Resolution Limit} = 0.5 \cdot tr_{sys} \cdot V_p \quad (6)$$

Where:

$tr_{sys}$  = the TDR system rise time or fall time, 10% to 90%

$V_p$  = the signal propagation velocity, same as  $V_f$

The total system rise time ( $tr_{sys}$ ) includes all components from the DUT to the scope, in other words, the TDR, scope, and probes. The  $tr_{sys}$  is shown by EQ(7). It should be noted that the rise time from 10% to 90% is arbitrary, in other words, 20% to 80% could also be used for each component in the  $tr_{sys}$  calculation. It only matters that the rise time values are consistent across all components.

$$tr_{sys} = \sqrt{tr_{TDR}^2 + tr_{scope}^2 + tr_{probe}^2} \quad (7)$$

Where:

$tr_{TDR}$  = the TDR rise time or fall time, 10% to 90%

$tr_{scope}$  = the oscilloscope rise time or fall time, 10% to 90%

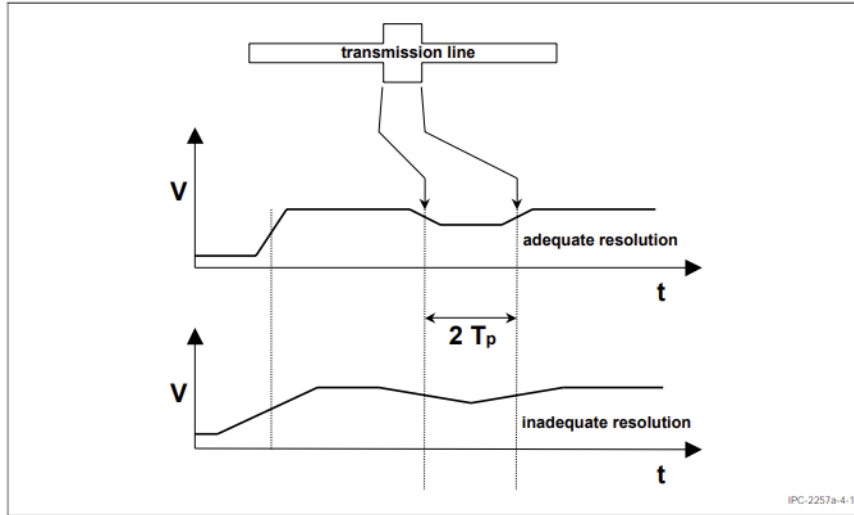
$tr_{probe}$  = the probe rise time or fall time, 10% to 90%

From the  $tr_{sys}$  the total system equivalent bandwidth can be found by EQ(8).

$$BW_{sys} = \frac{0.35}{tr_{sys}} \quad (8)$$

Where:

$BW_{sys}$  = the total system equivalent bandwidth



**Fig. 6 - Resolution and Electrical Length of Transmission Line [4].**

A simple example of adequate and inadequate resolution is shown by Figure 6. This will be discussed in more detail in section 4.3.

**EXAMPLE 1 - TDR RESOLUTION LIMIT EXAMPLE WITH P2104A 1-PORT PDN PROBE**

As an example of how to calculate the resolution limit, if the transmission line  $D_k = 3.5$ , then by EQ(4),  $V_f = 6.33$  in/ns. The P2104A 1-port probe has a bandwidth of 6.43 GHz. From EQ(8), we can calculate the probe's rise time as

$$P2104A \ tr_{probe} = \frac{0.35}{6.43 \text{ GHz}} = 54.4 \text{ ps} \tag{9}$$

For the J2154A TDR,  $tr_{TDR} = 30\text{ps}$ . For the MSO68B,  $tr_{scope} = 40\text{ps}$ . For the P2104A 1-port probe,  $tr_{Probe} = 54.4 \text{ ps}$ . Thus by EQ(7),  $tr_{sys}$  is

$$tr_{sys} = \sqrt{(30\text{ps})^2 + (40 \text{ ps})^2 + (54.4 \text{ ps})^2} = 75.6 \text{ ps} \tag{10}$$

$$BW_{sys} = \frac{0.35}{75.6\text{ps}} = 4.63 \text{ GHz} \tag{11}$$

With reference to EQ(6) and EQ(10), the resolution limit for the J2154A TDR with MSO68B, using the P2104A 1-port probe, with  $D_k = 3.5$  is calculated to be

$$Resolution \ Limit = 0.5 \cdot 75.6 \text{ ps} \cdot 6.33 \text{ in/ns} = 0.239 \text{ in} = 239 \text{ mils} \tag{12}$$

**EXAMPLE 2 - TDR RESOLUTION LIMIT EXAMPLE WITH P2105A TDR PROBE**



As an example of how to calculate the resolution limit, if the transmission line  $D_k = 3.5$ , then by EQ(4),  $V_f = 6.33$  in/ns. The Picotest P2105A TDR probe has a bandwidth of 16.5 GHz. From EQ(8), we can calculate the probe's rise time as

$$P2105A \ tr_{probe} = \frac{0.35}{16.5 \text{ GHz}} = 21.21 \text{ ps} \quad (13)$$

For the J2154A TDR,  $tr_{TDR} = 30\text{ps}$ . For the MSO68B,  $tr_{scope} = 40\text{ps}$ . For the P2105A TDR probe,  $tr_{probe} = 21.21 \text{ ps}$ . Thus by EQ(7),  $tr_{sys}$  is

$$tr_{sys} = \sqrt{(30 \text{ ps})^2 + (40 \text{ ps})^2 + (21.21 \text{ ps})^2} = 54.31 \text{ ps} \quad (14)$$

$$BW_{sys} = \frac{0.35}{54.31 \text{ ps}} = 6.44 \text{ GHz} \quad (15)$$

With reference to EQ(6) and EQ(14), the resolution limit for the J2154A TDR with MSO68B, using the P2105A TDR probe, with  $D_k = 3.5$  is calculated to be

$$Resolution \ Limit = 0.5 \cdot 54.31 \text{ ps} \cdot 6.33 \text{ in/ns} = 0.1719 \text{ in} = 171.9 \text{ mils} \quad (16)$$

When looking at the resolution limits between EXAMPLE 1 and EXAMPLE 2, it becomes clear as to the impact that having a higher bandwidth probe such as the P2105A in comparison to the lower bandwidth option has on the TDR during measurement. Mathematically, it is shown we are able to measure structures (or artifacts) almost 60 mils closer together just by having the higher bandwidth (16GHz) P2105A TDR probe vs. the lower bandwidth (6.43GHz) P2104A 1-port probe. Lastly, by comparing results from EQ(11) and EQ(15), we can see the system bandwidth impacts on the system, by having a 1.5 GHz increased bandwidth with the P2105A probe.

## 2.0 Test Equipment List

Table 1 - Test Equipment List

Description	Model	QTY
Tektronix 10GHz Oscilloscope	MSO68B [5]	1
Picotest PerfectPulse® Differential TDR	J2154A [6]	1
Picotest PDN Cable®, BNC-SMA, 0.25 meter	BNCJ/SMAJ-250 [7]	2 <sup>(1)</sup>
Picotest PDN Cable®, SMA-Mini SMP, 0.25 meter	SMAJ/SMPMK-250 [7]	2 <sup>(1)</sup>
Picotest 1-Port Probe	P2104A - 1X attenuation [8]	2 <sup>(1)</sup>
Picotest TDR Probe	P2105A [9]	2 <sup>(1)(2)</sup>
3D Probe Positioner	Keysight N2787A [10] or ClampMan Probing Solution [11]	2 <sup>(1)</sup>
50-ohm Load	Amphenol Connex 132360 [12]	1

**Table 1 Notes:**

1. QTY of two (2) is needed for differential TDR measurements, only one item is needed for single-ended TDR measurements.
2. The P2105A TDR probe can be used as a higher bandwidth alternative to the P2104A 1-port probe. The P2105A is only available in a 1X attenuation option.
3. The P2104A is available in multiple attenuation options. However, the J2154A TDR only works with 1X attenuation.

### 3.0 TDR Single-Ended Measurement Setup

Before you begin making measurements with the TDR, it is first important to make a couple of checks. If necessary, you can first verify that with no connection (an open) on the TDR SMA connector of the TDR, the scope input is factory trimmed to be ~250mV.

It is advisable to verify the instrument cables and interconnects at regular intervals. Cable crimps frequently degrade, particularly in low-cost cables, and can significantly impact the quality of the measurement.

The Tektronix software includes the pulse voltage, reflection coefficient, impedance, and capacitor and inductor calculations for single-ended measurements as well as the differential impedance for differential measurements.

In order to set up the TDR on the oscilloscope, we first need to scale the actual input pulse to a +/- 1V signal, which is also defined as the reflection coefficient ( $\Gamma$ ). The polarity of the actual input pulse is arbitrary. In other words,  $\Gamma$  needs to meet the specific criteria for open, 50 $\Omega$  match, short to ensure it is set appropriately before we use  $\Gamma$  to calculate our impedance. This is demonstrated by referencing EQ(17) and shown in Figure 7. Further, discussion on this topic is demonstrated in Picotest's Master the Fundamentals of Power Integrity and Power Supply Testing, Lesson 12: TDR Measurements [14]. With reference to EQ(17), ideally, the 0.0mV would be zero and the 250mV would be 250.00mV. However, that is not always the case, which is how we can add some calibration on the received pulse from the J2154A by appropriately scaling  $\Gamma$  before calculating impedance. This calibration can be observed in the equation depicted in Figure 7.

$$\Gamma = 2 \cdot \frac{\text{scopeInputChannel} - 0mV}{-250.00mV - 0mV} - 1 \quad (17)$$

For Open  $\square \Gamma = +1V$

For 50 $\Omega$  match  $\square \Gamma = 0V$

For Short  $\square \Gamma = -1V$

Note: A 50 $\Omega$  load, as defined in Table 1, can be used for the 50 $\Omega$  match.

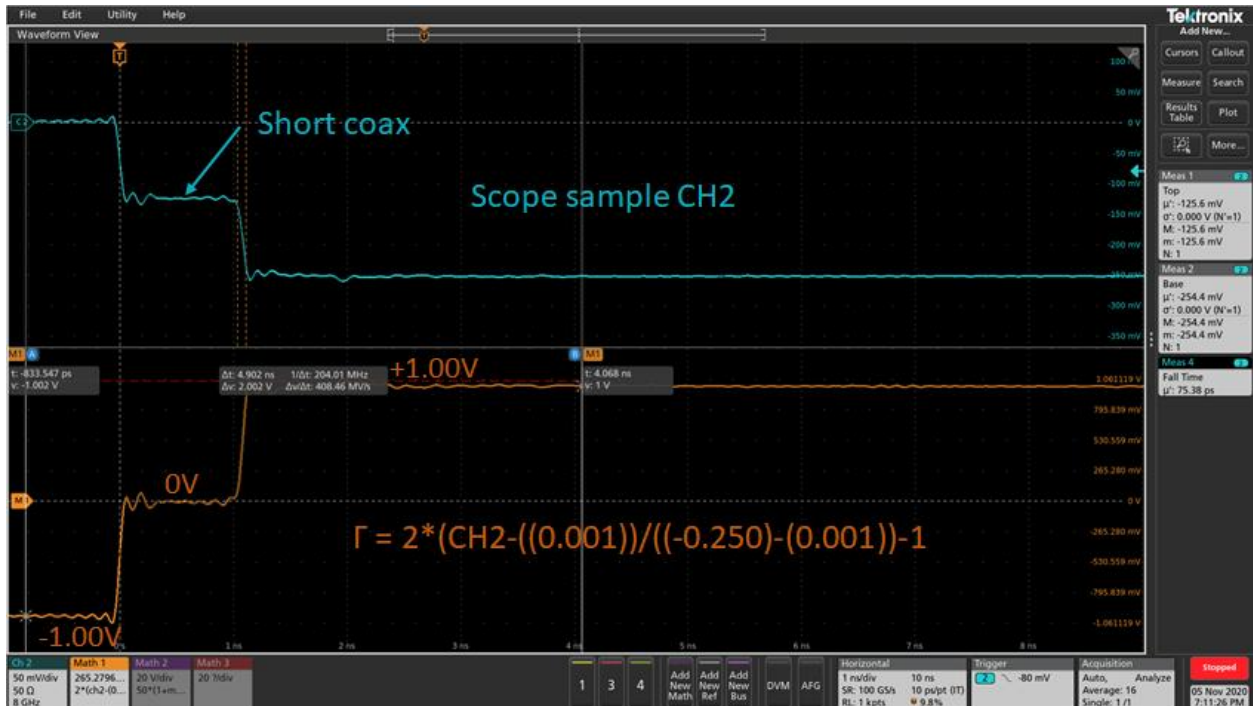
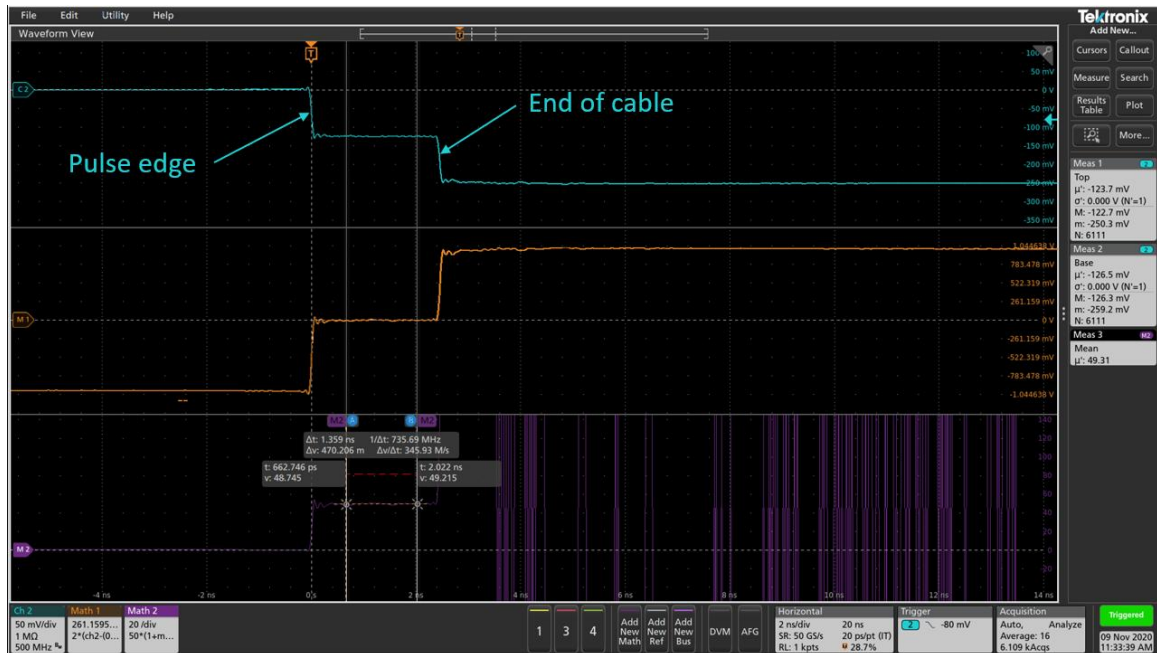


Fig. 7 - TDR Setup - Short, Open, Load.

When using a TDR, it is important to set your reference point. If you are using an SMA connection between the TDR and the DUT, then it is important to understand where to reference (in time) on the scope where your DUT measurement begins. You can find the pulse launch by setting the trigger to the pulse channel, which is CH2, as shown by Fig. 8.

Some simple techniques can be followed to quickly get your bearings with the TDR reference point..

1. Connect only your 50Ω cable to the TDR and note where the far edge starts to change on the reflection coefficient and impedance traces on the oscilloscope. An example is shown in Figure 8 below.
  - a. It will be the same time point for both of these traces. This signifies the end of your cable.
  - b. Now, set your time span so that this edge is on the left side of the scope.



**Fig. 8 - TDR Pulse Edge and End of Cable Edge.**

2. Next, if you are using a probe, connect the probe to the cable and note any inductive changes.
  - a. The J2154A comes with a demo board you can measure. Place the probe on the trace, as shown in Figures 9 and 10. Note the inductive (positive) blips that occur on the impedance trace and reflection coefficient. This is the inductance from the probe, in this case, the P2105A TDR probe. Your reference point where your DUT measurement starts is to the right of these inductive blips, as shown by Figure 10.



**Fig. 9 - TDR Setup on 50Ω Microstrip Transmission Line with the P2105A Probe.**

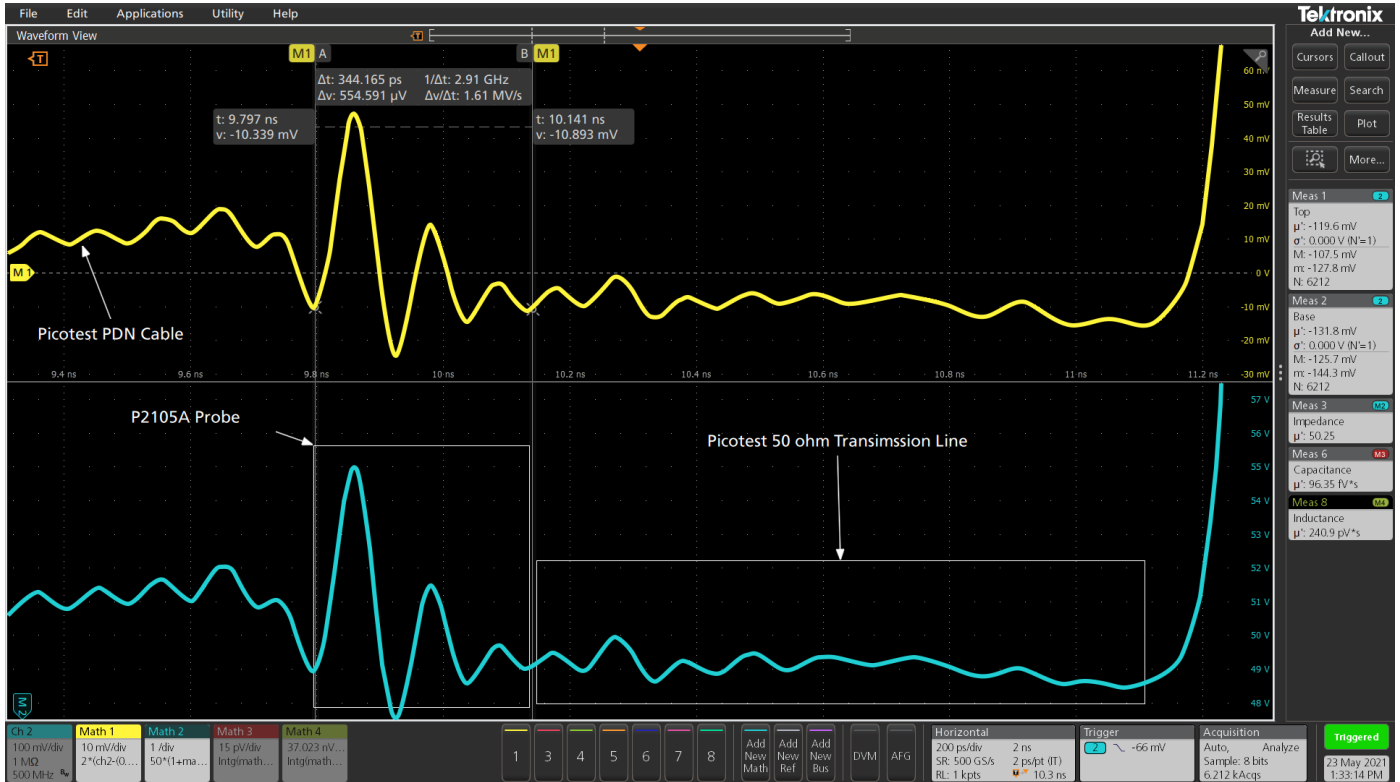


Fig. 10 - TDR Setup on 50Ω Microstrip Transmission Line with the P2105A Probe.

## 4.0 TDR Measurement Results

### 4.1 Using a TDR to Measure Single-Ended Signals

As shown in Section 3, the reflection coefficient  $\Gamma$  was calculated by EQ(17) and also shown in Figure 7.

$$\Gamma = \frac{R_{ref} - Z_{DUT}}{R_{ref} + Z_{DUT}} \quad (18)$$

From EQ(18), the impedance of the DUT is solved for and shown by EQ(19).

$$Z_{DUT} = R_{ref} \cdot \frac{1 + \Gamma}{1 - \Gamma} \quad (19)$$

Where Table 2, in the Appendix, defines the necessary math functions to set up a single-ended impedance measurement.

## 4.2 Using a TDR to Measure Inductance and Capacitance

A TDR can also be used to measure series inductance, as well as shunt capacitance. Where series inductance shows up as positive blips and shunt capacitance shows up as negative blips, as depicted by Figure 11 below. One thing that can be confusing is that this depends on whether the pulse is rising or falling. The J2154A uses two negative-going pulses, where one of them is complimentary. We fixed this by normalizing our reflection coefficient ( $\Gamma$ ) such that the open is +1V and the short is -1V.

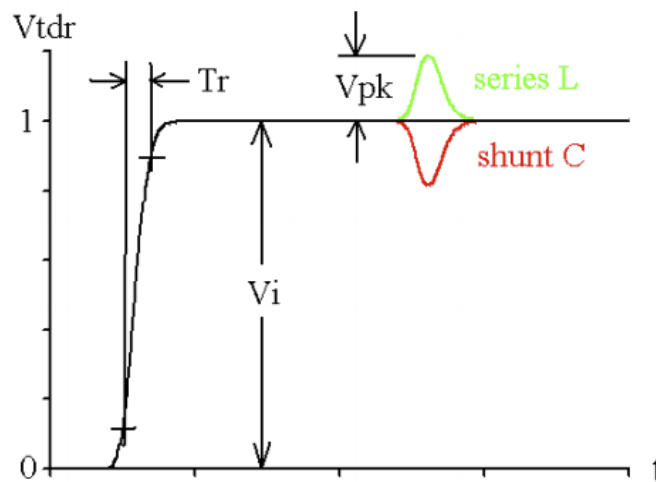


Fig. 11 - TDR Example of Series Inductance (L) and Shunt Capacitance (C) [15].

If the cursors are put at the start and end of one of the blips, either inductance or capacitance can be found by integrating across the respective blip. These methods are well defined in a Signal Integrity Journal article by Steve Sandler [16] by using the oscilloscope cursors to measure either series inductance or shunt capacitance.

To start, set the waveform cursors at each edge of the blip, one at the start of the blip, and one at the end of the blip, and use math functions to integrate with respect to time to calculate either the shunt capacitance or series inductance. The math functions needed for calculating capacitance and/or inductance are defined in Table 2 in the Appendix. Where EQ(20) below represents the integral equation for shunt capacitance and can be approximated by EQ(21). EQ(22) is the integral equation for series inductance and can be approximated by EQ(23). Where  $R_{ref}$  is assumed to be  $50\Omega$ .

$$C = \frac{2}{R_{ref}} \int_0^{\infty} \Gamma \cdot dt \quad (20)$$

$$C \approx \frac{2}{R_{ref}} \cdot \Delta\Gamma \cdot t \quad (21)$$

$$L = 2 \cdot R_{ref} \int_0^{\infty} \Gamma \cdot dt \quad (22)$$

$$L \approx 2 \cdot R_{ref} \cdot \Delta \Gamma \cdot t \quad (23)$$

As shown in Figures 12, 13, and 14, a 3 pF chip cap is soldered in the middle of a 50Ω microstrip trace that does not have solder mask, in a shunt configuration.

As observed by the waveform from the oscilloscope, 3pF is relatively easy to see, so you could generally measure well below a pF with the Picotest TDR.

The gated cursor math function displays the capacitance as 3.07pF, which is within the 10% tolerance of the 3pF capacitor.

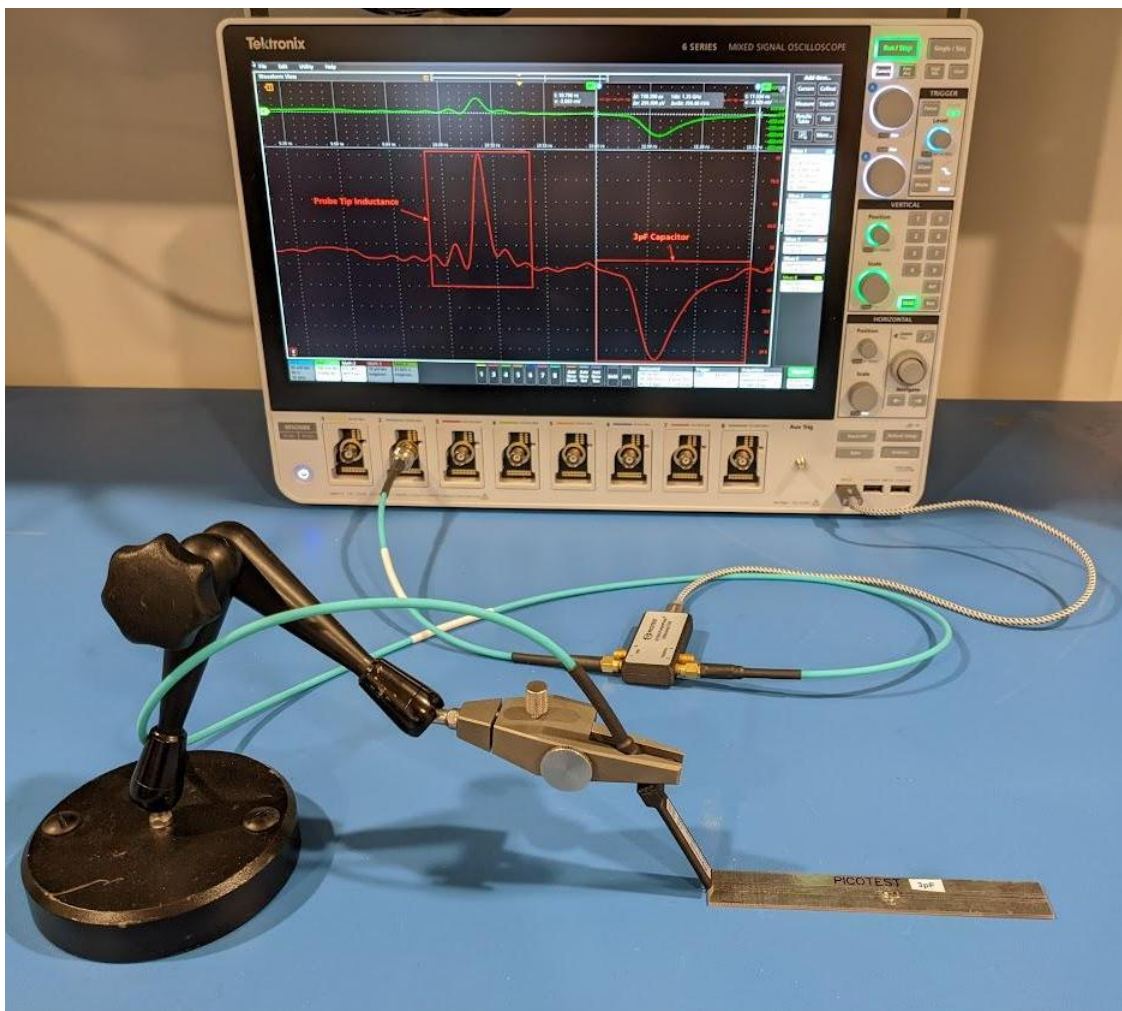




Fig. 12 - TDR Measurement Setup for a 3pF Capacitor Test PCB with the P2104A Probe and J2154A TDR.



Fig. 13 - TDR Measurement Setup for 3pF Capacitor with the P2104A Probe.



Fig. 14 - TDR Measurement Result of the 3pF Capacitor with the P2104A Probe and J2154A TDR.

As shown in Figures 15 and 16, a 500 fF chip cap is soldered in the middle of a 50Ω microstrip trace that does not have solder mask, in a shunt configuration. As observed by the oscilloscope waveform, shown in Figure 16, 552 fF of capacitance is measured, again within the 10% tolerance of this chip capacitor.

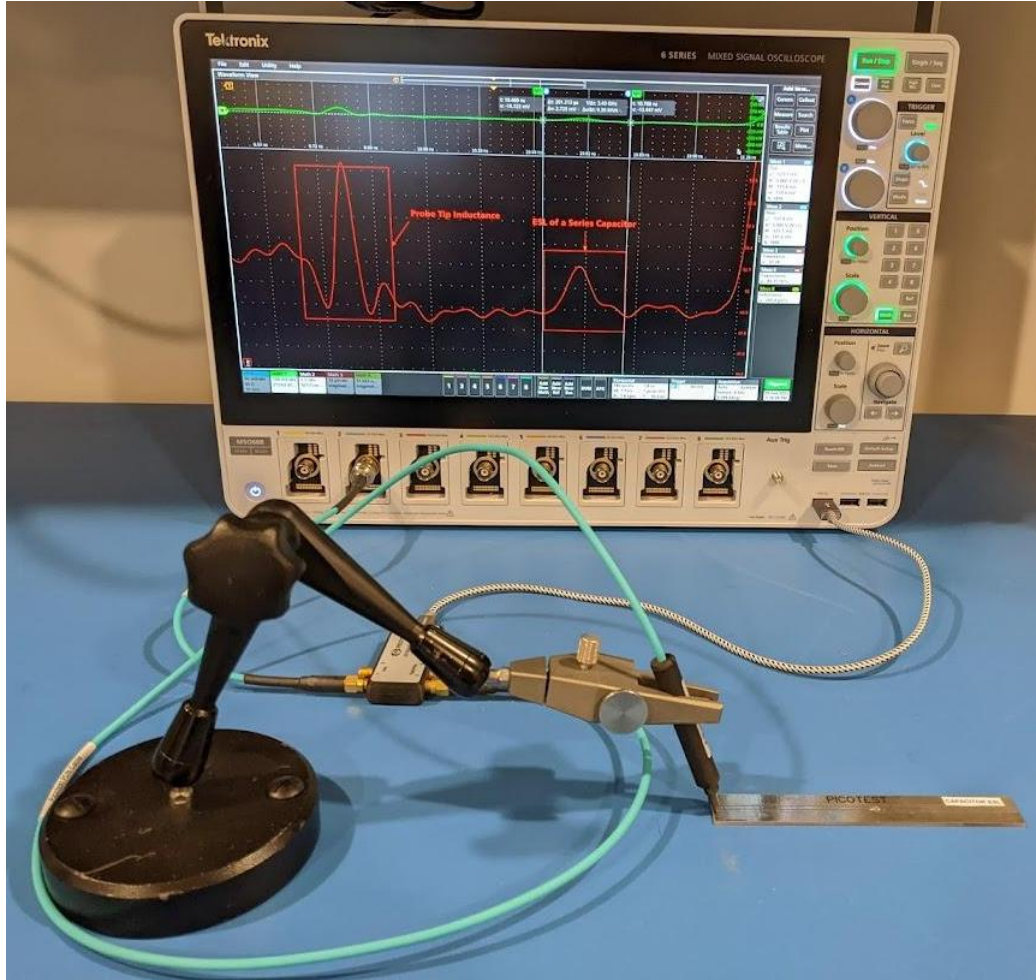


Fig. 15 - TDR Measurement Setup for 500fF Capacitor with the P2104A Probe.



Fig. 16 - TDR Measurement Result of a 500fF Capacitor with the P2104A Probe and J2154A TDR.

As shown in Figures 17, 18, and 19, a ceramic chip cap is soldered in series with the 50Ω microstrip trace. As observed by the oscilloscope waveform, shown in Figure 19, 187.2 pH of inductance is measured.



**Fig. 17 - TDR Measurement Setup of Series Capacitor ESL with the P2105A Probe.**



**Fig. 18 - TDR Measurement Setup of Series Capacitor ESL with the P2105A Probe.**



Fig. 19 - TDR Measurement Result of Series Capacitor ESL with the P2015A Probe.

### 4.3 Using a TDR to find $D_k$

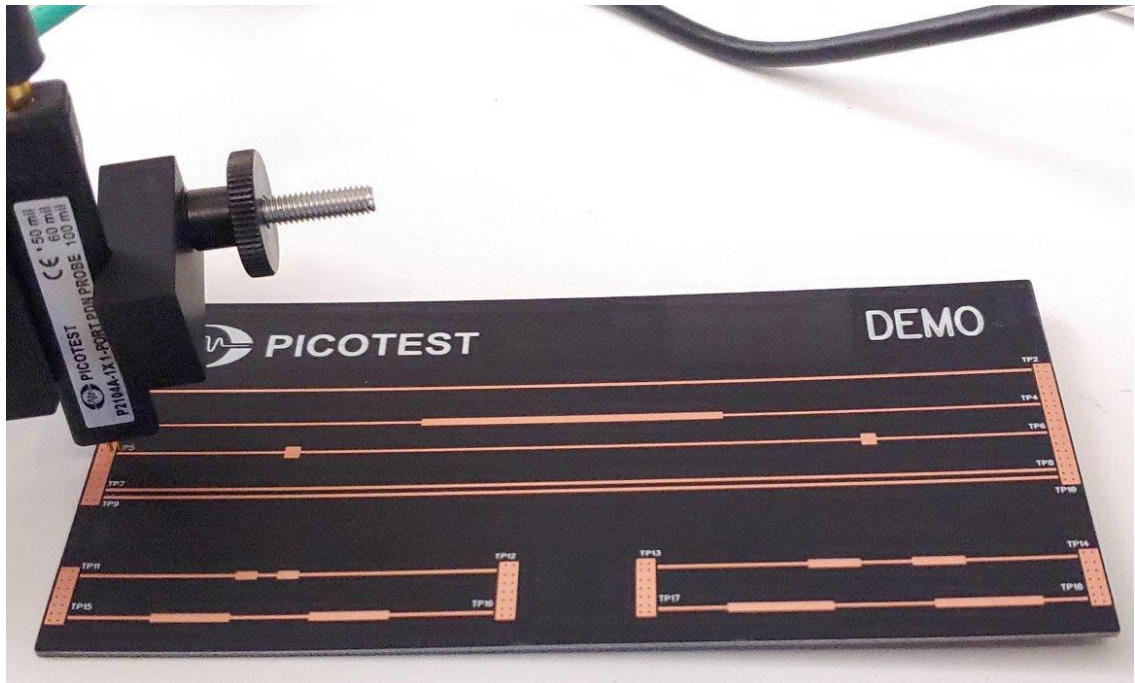
Length, time, and the dielectric constant are all related. If we know any two of the three, we can use a TDR to solve for the third. If we are using a defined structure where we know the length of the transmission line, then we can measure time and calculate the dielectric constant. This method can also be used to determine the time delay between two matched cables if the dielectric constant ( $D_k$ ) is known. Or vice versa, to calculate the cable's  $D_k$  by measuring the time delay. However, in a microstrip, the effective dielectric the signal sees is not the bulk value of the laminate.

$$Length_{line} = \frac{11.86}{\sqrt{D_k}} \cdot \frac{\Delta Time (ns)}{2} \quad (24)$$

$$D_k = \left[ \frac{5.9 \cdot Time (ns)}{Length (in)} \right]^2 \quad (25)$$

With EQ(24), we can solve for  $D_k$  to get EQ(25), which can be used to calculate  $D_k$  after using the TDR to measure the round trip time between any two structures, such as those shown on the DUT, depicted by Figure 20.

Figure 20 depicts the test setup used for this measurement on a Picotest test PCB using the P2104A 1-port probe, where a trace with structures spaced three inches apart is measured with the J2154A TDR.



**Fig. 20 - TDR Measurement Setup with Picotest Demo Board TP5 Trace Using the P2104A Probe.**

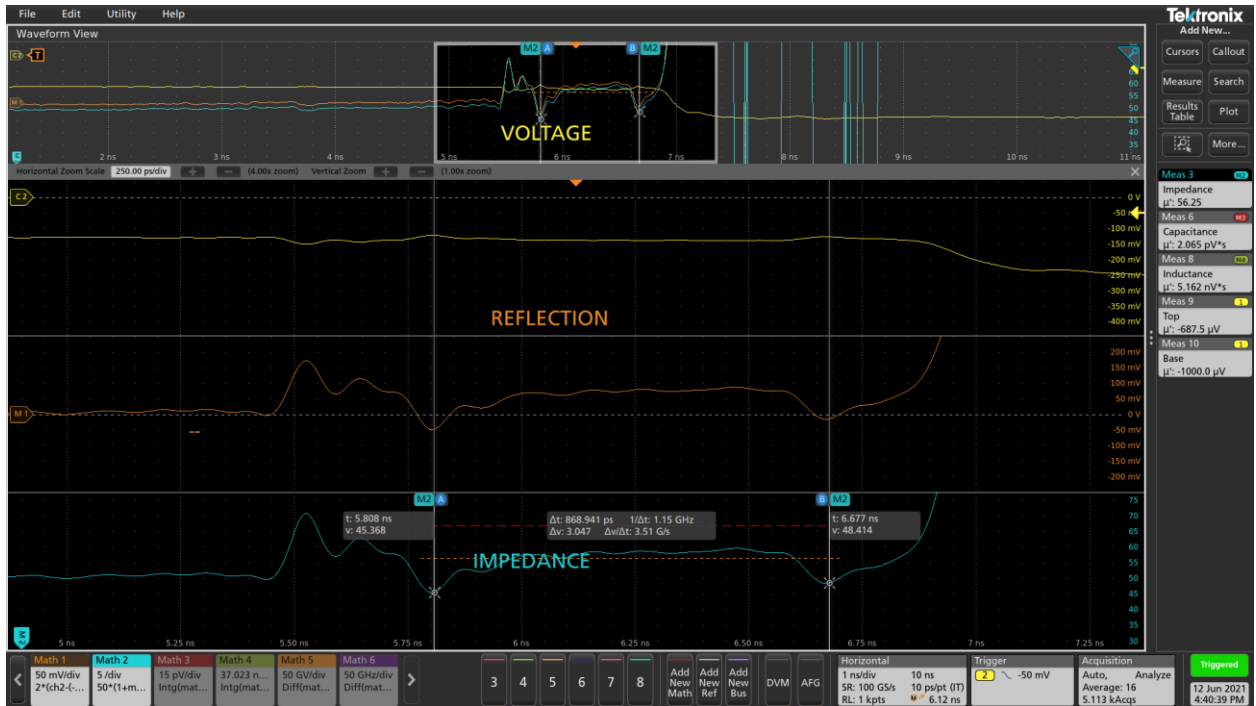


Fig. 21 - TDR Measurement of Picotest Demo Board TP5 Trace with the P2104A Probe.



Fig. 22 - TDR Measurement Setup with Picotest Demo Board TP5 Trace with the P2105A Probe.

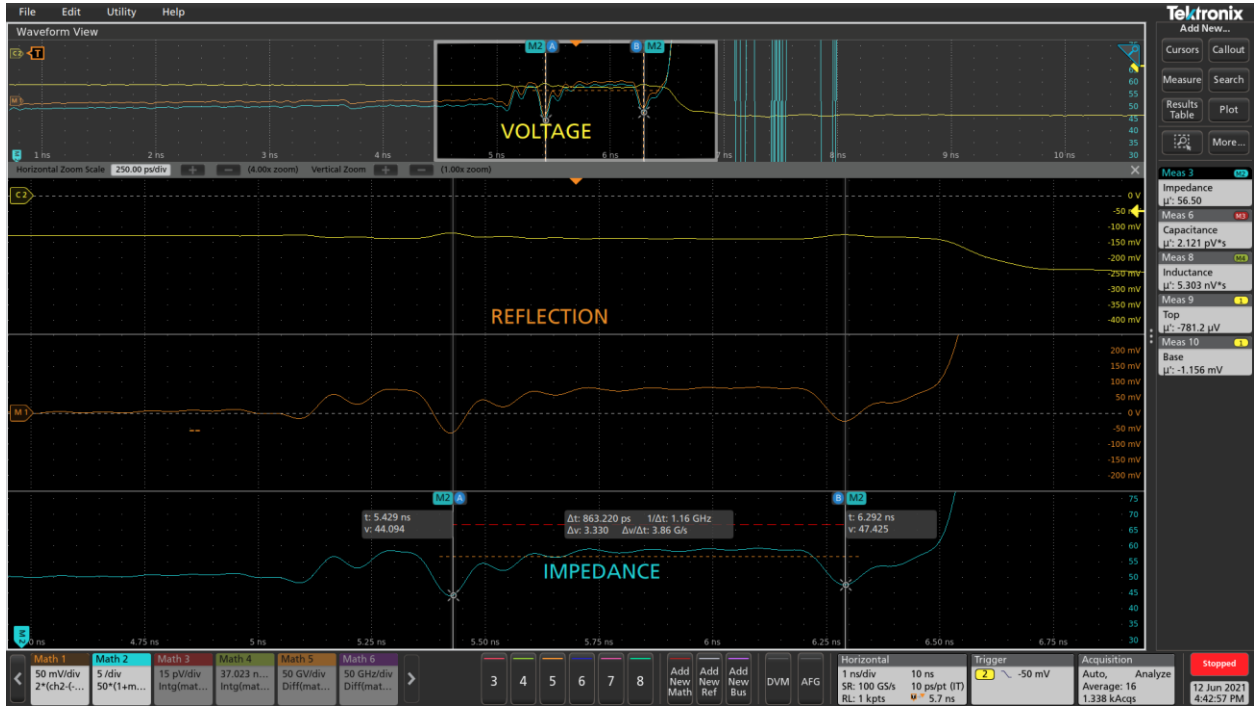


Fig. 23 - TDR Measurement of Picotest Demo Board TP5 Trace with the P2105A Probe.

The Picotest Demo board shown in Figure 22, is a two-layer PCB using Rogers RO4003C, which has a bulk  $D_k = 3.55$  [17]. As shown by the results in Figure 21, we can easily measure the 3-inch microstrip trace. As shown by the result in Figure 21, with the P2104A 1-port probe, the round trip time measured between the aberrations is 868.9 ps.

With reference to EQ(25), and the measured result in Fig. 21 with the P2104A probe, we can calculate the Picotest test board's  $D_{keff}$  to be:

$$D_{keff} = \left[ \frac{5.9 - 0.8689}{3} \right]^2 = 2.92 \quad (26)$$

However, since we are measuring a microstrip, this is the effective value of the combination of the bulk dielectric constant and the contribution of the field line in air with  $D_k = 1$  [17]. One method to approximate the bulk dielectric constant to the effective dielectric constant is shown by using EQ(27) and EQ(28).

Where EQ(27) calculates a correction factor (a), using the trace width (w) and the dielectric thickness (h).

$$a = \frac{1}{\sqrt{1 + 12(h/w)}} \quad (27)$$

Where on the Picotest demo board shown in Figure 22, the trace width (w) equals 14.9 mils and the dielectric thickness (h) equals 8 mils. From EQ(27),  $a = 0.366$ . Using the correction factor, the bulk dielectric can be found by EQ(28):

$$D_k = \frac{2 \cdot D_{keff} - 1 + a}{1 + a} \quad (28)$$

With reference to EQ(27), as well as EQ(28) and the result shown in EQ(26), we can find the bulk dielectric constant  $D_k$  based on what was measured with the P2104A probe. This result is shown by EQ(29).

$$D_k = \frac{2 \cdot D_{keff} - 1 + a}{1 + a} = \frac{2 \cdot 2.92 - 1 + 0.366}{1 + 0.366} = 3.81 \quad (29)$$

Whereas shown in Figure 23, the round trip time measured between the two aberrations with the P2105A probe is 863.2 ps.

With reference to EQ(25), and the measured result in Figure 23 with the P2105A probe, we can calculate the Picotest test board's  $D_{keff}$  to be:

$$D_{keff} = \left[ \frac{5.9 \cdot 0.86327}{3} \right]^2 = 2.88 \quad (30)$$

With reference to EQ(27), as well as EQ(28) and the result shown in EQ(30), we can find the bulk dielectric constant  $D_k$  based on what was measured with the P2105A probe. This result is shown by EQ(31).

$$D_k = \frac{2 \cdot D_{keff} - 1 + a}{1 + a} = \frac{2 \cdot 2.88 - 1 + 0.366}{1 + 0.366} = 3.75 \quad (31)$$

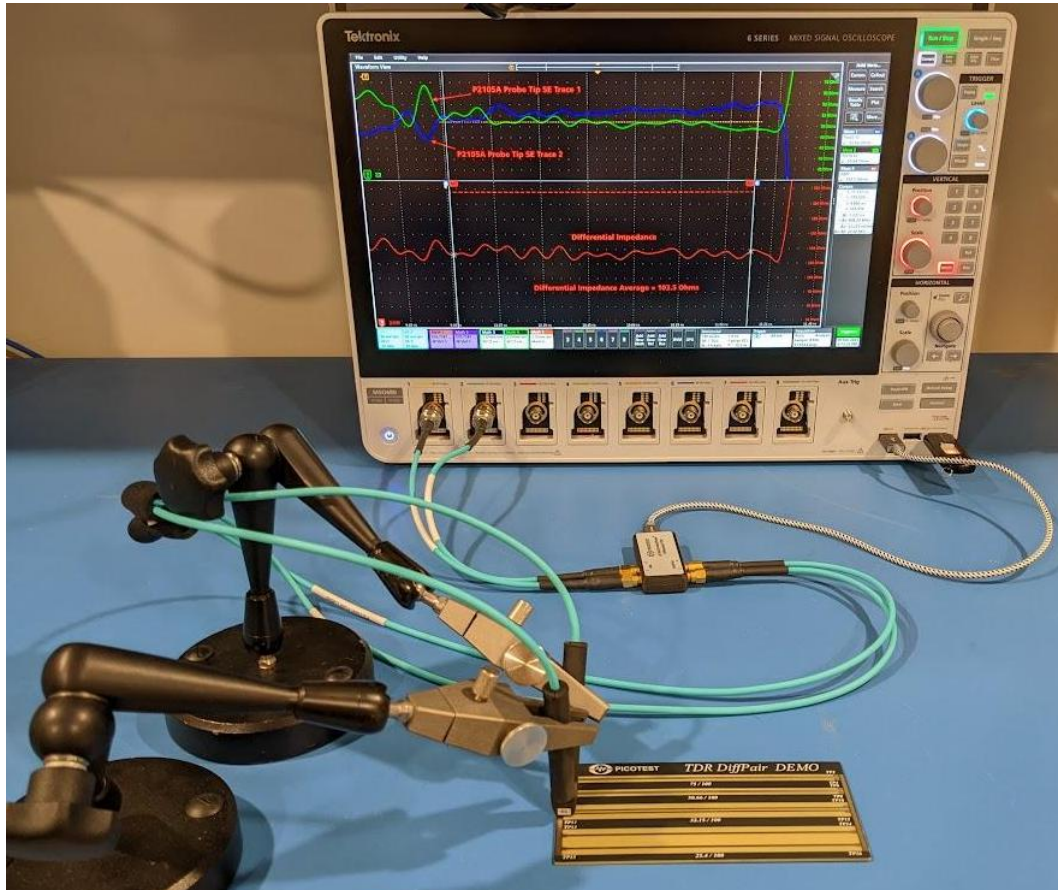
As discussed earlier, since the trace measured on the Picotest TDR demo board is a microstrip, the results shown by EQ(26) and EQ(30) do not represent the bulk dielectric constant. However, the results shown by EQ(29) and EQ(31) do represent an approximated value for the bulk dielectric constant, which is shown to be very close to the datasheet value for Rogers RO4003C [17]. The only way of converting the measured effective dielectric constant into the bulk laminate dielectric constant for Rogers RO4003C is using a 2D field solver. Lastly, it is important to remember the dielectric constant is frequency and thickness-dependent.

#### 4.4 Using a TDR to Measure Differential Signals

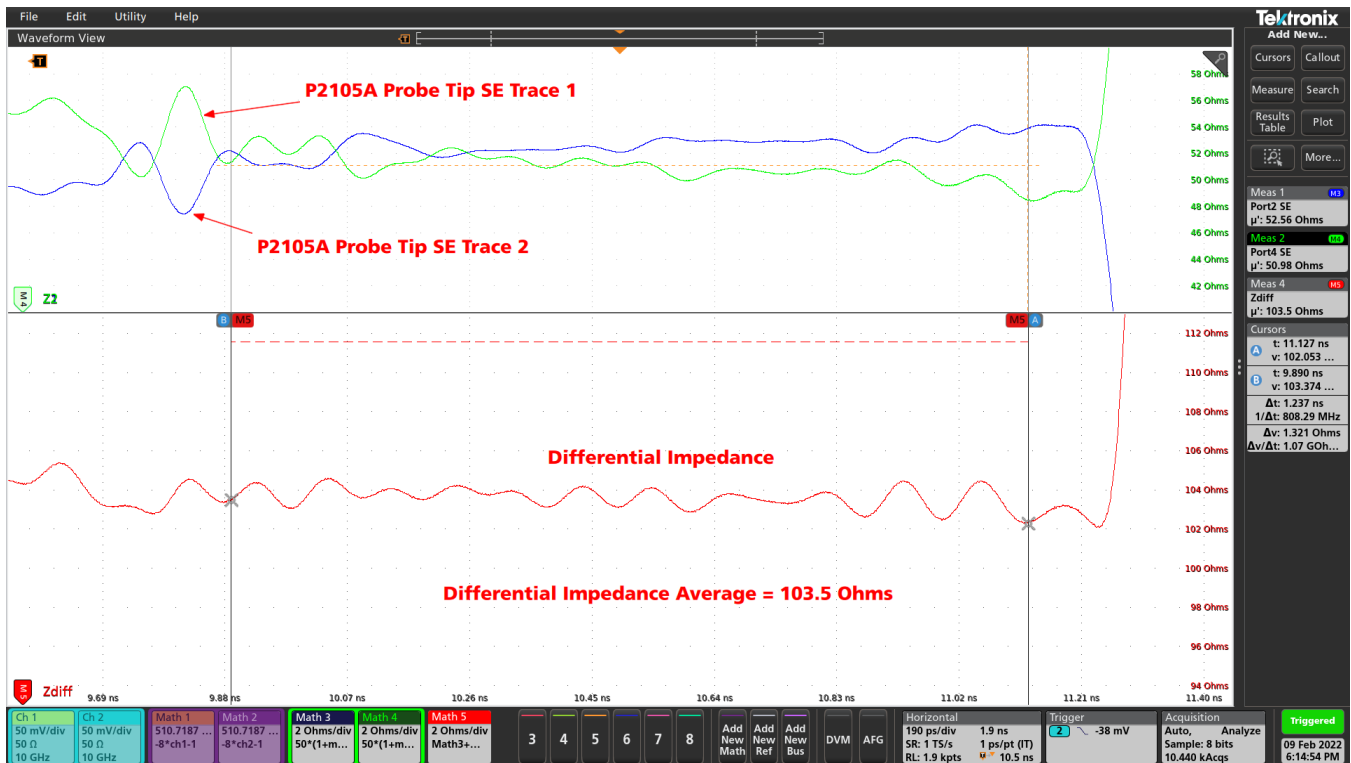
Setup of the J2154A TDR for differential measurement applications is very similar to the TDR single-ended measurement setup defined in Section 3. The big difference being two channels are used on the oscilloscope as well as on the J2154A TDR. This allows measurement of any differential pair such as CLKs, PCIe, MiPi, HDMI, DDR strobes, etc. The math functions to set up for a differential TDR measurement are defined in Table 3 of the



Appendix. In addition, similarly, to making single-ended TDR measurements, it is also important to set your reference point when making differential TDR measurements.

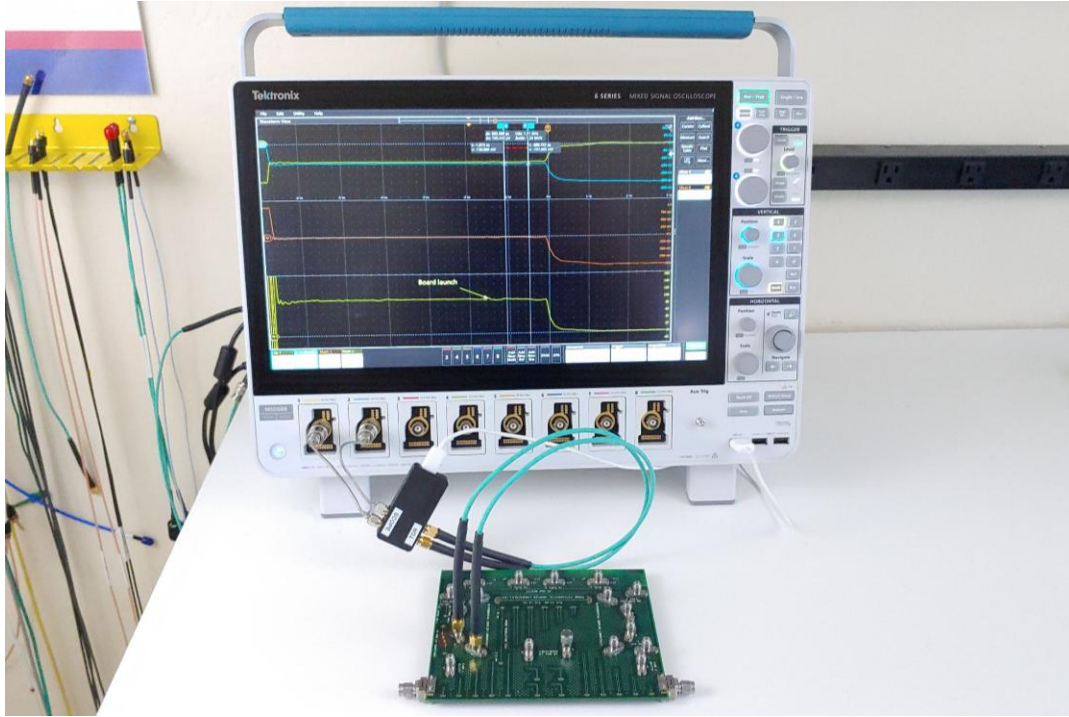


**Fig. 24 - Differential TDR Measurement Setup with Two (2) P2105A Probes on the Picotest TDR DiffPair Demo Board (TP9/TP11).**



**Fig. 25 - Differential TDR Measurement Result with the P2105A Probes on the Picotest TDR DiffPair Demo Board (TP9/TP11).**

Figure 24 provides a depiction of the setup used to measure a 4-inch differential pair using the Picotest J2154A TDR and two Picotest P2105A probes. As shown by the results in Figure 25, we are easily able to measure the 4-inch differential pair. The results show the average differential impedance is 103.5Ω.



**Fig. 26- Differential TDR Measurement Setup with Direct SMA Connections to DUT.**

Figure 26 provides another example of how to use the J2154A to make direct connections to a DUT to capture information on differential traces.

The results of this measurement are shown in Figure 27, where the average differential impedance is found to be  $\sim 98\Omega$ .

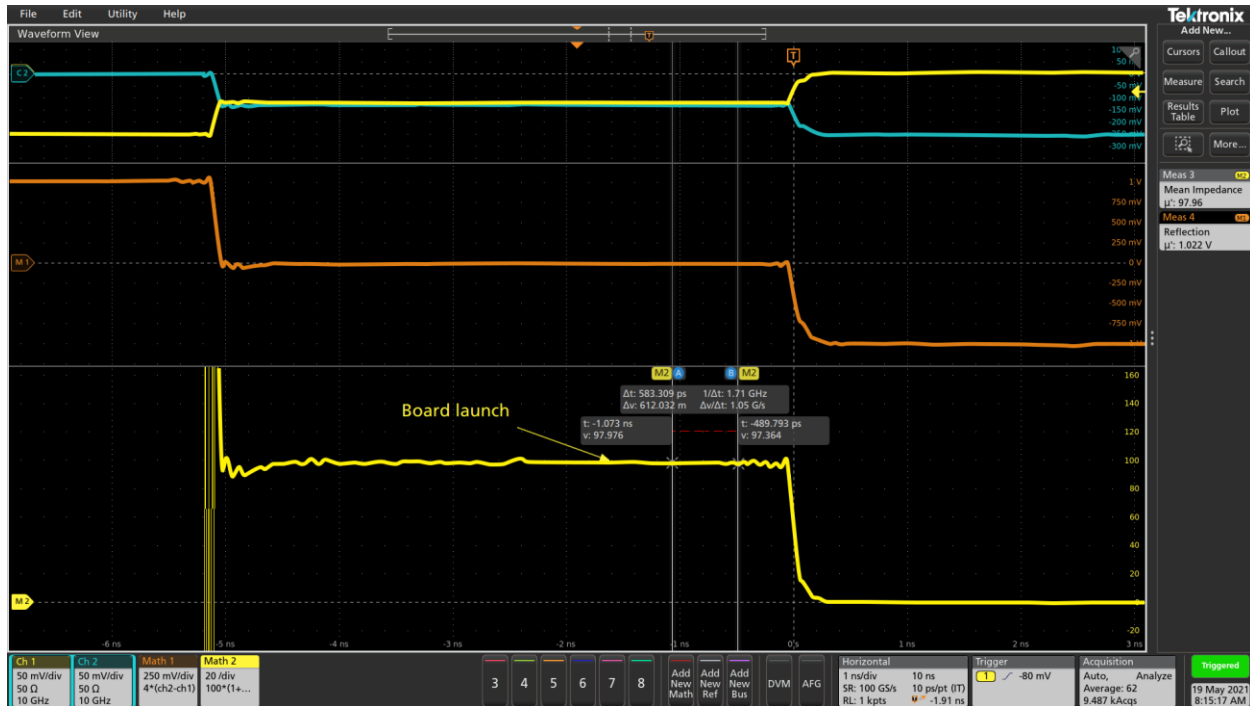


Fig. 27 - Differential TDR Measurement Result with Direct SMA Connections to DUT.

## 5.0 Conclusion

The Picotest J2154A PerfectPulse® Differential TDR can be used to measure PCB coupons and cable impedance, dielectric constant, transmission line length, distance, distance to fault, inductance, and capacitance.

In addition to being a differential TDR, since the Picotest J2154A TDR has two channels, it could also be used as a Time Domain Transmission (TDT) to measure both the near-end crosstalk (NEXT) and far-end crosstalk (FEXT). This can provide the propagation delay and insertion loss of the DUT and the skew between two coupled transmission lines such as a differential clock pair.

As discussed, the Picotest J2154A TDR, in conjunction with a Tek MSO6B Oscilloscope, can be used to:

- Verify controlled impedance traces, both differential and single-ended
- Find degradations or faults in cables, crimps, and solder joints
- Determine the length of a cable or trace
- Fault location (cable TV companies use this frequently)

Lastly, the measurement rise time and bandwidth are functions of the signal generator (from the TDR), power divider, oscilloscope, and probe - all of which impact the resolution of the structures that can be measured on your DUT.

When using a TDR there are some important factors to keep in mind that can affect accuracy:

- Step generator edge speed and fidelity
- Receiver bandwidth and frequency response
- Probe bandwidth
- Cables, adapters, and the fixture between the instrument and DUT
- Skew and step match when making differential measurements

It is highly recommended that a clamping solution such as the Picotest Probe holder, be used to assist with probe holding and positioning and to improve measurement consistency.

## 6.0 References

1. TDR Impedance Measurement: A Foundation for Signal Integrity - [https://download.tek.com/document/55W\\_14601\\_2.pdf](https://download.tek.com/document/55W_14601_2.pdf)
2. TDR: Reading the Tea Leaves - [https://www.sisoft.com/uploads/TDR\\_Reading\\_the\\_Tea\\_Leaves\\_MS.pdf](https://www.sisoft.com/uploads/TDR_Reading_the_Tea_Leaves_MS.pdf)
3. Barnes, H. et al. "Signal Integrity Tips and Techniques Using TDR, VNA and Modeling." Signal Integrity Journal, March 2016. <https://www.signalintegrityjournal.com/articles/174-signal-integrity-tips-and-techniques-using-tdr-vna-and-modeling>
4. IPC-<sup>TM</sup>-650 Test Methods Manual - [https://www.ipc.org/sites/default/files/test\\_methods\\_docs/2-5-5-7a.pdf](https://www.ipc.org/sites/default/files/test_methods_docs/2-5-5-7a.pdf)
5. Tektronix MSO68B Oscilloscope - <https://www.tek.com/oscilloscope/6-series-mso-mixed-signal-oscilloscope>
6. Picotest J2154A PerfectPulse® Differential TDR - [https://www.picotest.com/products\\_J2154A.html](https://www.picotest.com/products_J2154A.html)
7. Picotest PDN Cable® - <https://www.picotest.com/pdn-cable.html>
8. Picotest P2104A 1-Port Probe - <https://www.picotest.com/product/p2104a-1-port-transmission-line-pdn-probe/>
9. Picotest P2015A TDR Probe - <https://www.picotest.com/product/p2105a-1-port-low-noise-tdr-ripple-browser-probe/>
10. Picotest Probe Holder - <https://www.picotest.com/product/3dpp-200-picotest-probe-holder-set/>
11. RF Terminator SMA Male - 50 ohm Test Load - [https://www.amazon.com/dp/B0719C1T99?psc=1&ref=ppx\\_yo2\\_dt\\_b\\_product\\_details](https://www.amazon.com/dp/B0719C1T99?psc=1&ref=ppx_yo2_dt_b_product_details)
12. Picotest Tektronix Solutions Page - <https://www.picotest.com/tektronix.html>
13. Picotest - Master the Fundamentals of Power Integrity and Power Supply Testing - Lesson 12: TDR Measurements - <https://www.picotestonline.com/courses>
14. Time Domain Reflectometry (TDR) and Time Domain Transmission (TDT) Measurement Fundamentals - <https://kh6htv.files.wordpress.com/2015/11/an-15-tdr-tdt.pdf>
15. Sandler, S. "Measuring pH and fF With a TDR Using a Cursor Measurement." Signal Integrity Journal, January 2021. <https://www.signalintegrityjournal.com/articles/1997-measuring-ph-and-ff-with-a-tdr-using-a-cursor-measurement>
16. Rogers RO4000 Series High Frequency Circuit Material Datasheet - <https://rogerscorp.com/-/media/project/rogerscorp/documents/advanced-connectivity-solutions/english/data-sheets/ro4000-laminates-ro4003c-and-ro4350b---data-sheet.pdf>
17. Bogatin, E. "Bogatin's Practical Guide to Transmission Line Design and Characterization for Signal Integrity Applications." Artech House, 2020.

18. Picotest TDR Solutions Page - <https://www.picotest.com/measurements/MeasuringPCB.html>
19. PacketMicro TDR Solutions Page - <https://www.packetmicro.com/Applications/tdr-probing.html>
20. Sandler, S. "The Goldilocks TDR." Signal Integrity Journal, September 2020.  
<https://www.signalintegrityjournal.com/articles/1852-the-goldilocks-tdr>
21. Hernandez-Mejia, J. "Chapter 5 Time Domain Reflectometry (TDR)." Georgia Tech, 2016.  
[https://www.neetrac.gatech.edu/publications/CDFI/5-TDR\\_17\\_with-Copyright.pdf](https://www.neetrac.gatech.edu/publications/CDFI/5-TDR_17_with-Copyright.pdf)
22. Dannan, B., Sandler, S. "Measuring the Bulk Dielectric Constant (Dk) on a Microstrip with a TDR." Signal Integrity Journal, January 2022.  
<https://www.signalintegrityjournal.com/articles/2378-measuring-the-bulk-dielectric-constant-dk-on-a-microstrip-with-a-tdr>

## 7.0 Appendix

**Table 2 - Math Function for Single-Ended TDR Measurements with J2154A TDR**

Oscilloscope Math FCN	Math FCN EQ	Notes
Math1	$-8 \cdot Ch1 - 1$	Scales the actual pulse to a +/-1V signal as reflection coefficient ( $\Gamma$ )
Math2	$50 \cdot \frac{1 + Math1}{1 - Math1}$	Converts reflection coefficient ( $\Gamma$ ) to impedance ( $Z_{DUT}$ )
Math3	$INTG(Math1)/25$	Calculates Capacitance ( $C_{DUT}$ ) by integration of signal
Math4	$INTG(Math1) \cdot 100$	Calculates Inductance ( $L_{DUT}$ ) by integration of signal
Meas1	mean(Math2)	Provides the average single-ended impedance. Recommended to enable gated with cursors.

Note: All of the equations listed in Table 2 are set up already available with the supplied Tektronix software.

**Table 3 - Math Function for Differential TDR Measurements with J2154A TDR**

Oscilloscope Math/Measure FCN	Math FCN EQ	Notes
Math1	$-8 \cdot Ch1 - 1$	Calculates Reflection coefficient ( $\Gamma$ ) for Trace 1
Math2	$-8 \cdot Ch2 - 1$	Calculates Reflection coefficient ( $\Gamma$ ) for Trace 2
Math3	$50 \cdot \frac{1 + Math1}{1 - Math1}$	Converts reflection coefficient ( $\Gamma$ ) to impedance ( $Z_{DUT}$ ) for Trace 1
Math4	$50 \cdot \frac{1 + Math2}{1 - Math2}$	Converts reflection coefficient ( $\Gamma$ ) to impedance ( $Z_{DUT}$ ) for Trace 2
Math5	$Z_{diff} = Math1 + Math2$	Calculates the differential impedance
Meas5	mean(Math5)	Calculates the average differential impedance